



# NURAJACK™

DECKING MADE EASY



**TILE**

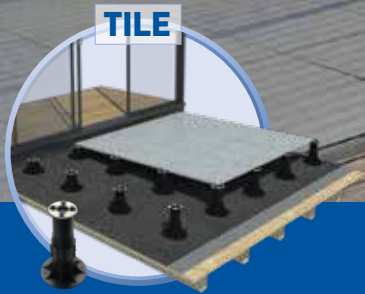

**TIMBER**



**NURASPIKE**



The ultimate deck pedestal solution

[www.nurajack.co.nz](http://www.nurajack.co.nz)

• IMAGE: WATER TREATMENT PLANT TAUPŌ NZ.

# The ultimate deck pedestal solution

NURAJACKS™ MAKE IT EASY FOR ALL DECKING REQUIREMENTS



- Creates a level deck surface
- Strong and stable - load tested to over 1000kg
  - Easy to replace tiles
  - Durable - 20 year warranty
- Easy access to waterproofing membrane below
  - Void accommodates services which can be placed under deck surface
    - Acoustic sound barrier
    - Windproof options
  - Level indoor-outdoor flow

**With NURAJACKS™, low profile decks have never been easier... jobs that were once time-consuming and complicated now run smoothly with efficiency & ease.**

**Our patented system means you can trust that your deck will be level and will meet Building Code & Council Standards.**

NURAJACKS™ are height adjustable. They allow the tiles or decking to be raised up to the level of the interior living space. This creates a level threshold with optimum indoor-outdoor flow.

When installing over waterproofing membrane, tiles and decking should be removable to allow access to the membrane below the surface. Your ultimate solution to achieve this is using NURAJACKS™ and NURAPADS™.

Laying a floor or deck with NURAJACKS™ is easy. The NURAJACKS™ rest on top of the substrate and the tiles or decking timber sit on the self-levelling head of

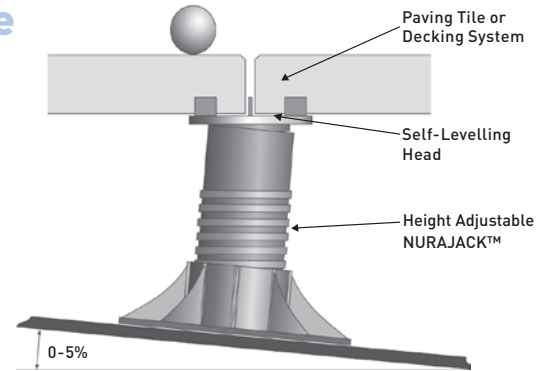

the NURAJACK™. The void between the decking and the substrate can be used to accommodate pipes and other services. The NURAJACK™ system does not use grout or adhesives. When it rains the water flows between the tiles and decking, onto the substrate and then unimpeded onto drainage. The NURAJACK™ system protects waterproof membranes from foot traffic and harsh UV sunlight so that it can keep your home dry.

Adding the NURAJACK™ SE Acoustic Pad is a cost-effective way to enhance the acoustic reduction properties of the system.





## TILE

The NURAJACK™ with self-levelling tile head can support structural tiles, stone and concrete pavers designed for floated applications. An integrated rubber pad minimises the tile or paver vibration which in turn minimises foot fall echo and tile movement. The self-levelling head ensures the tile is not point loaded and the large base of the NURAJACK™ ensures any membrane under the NURAJACK™ is protected.

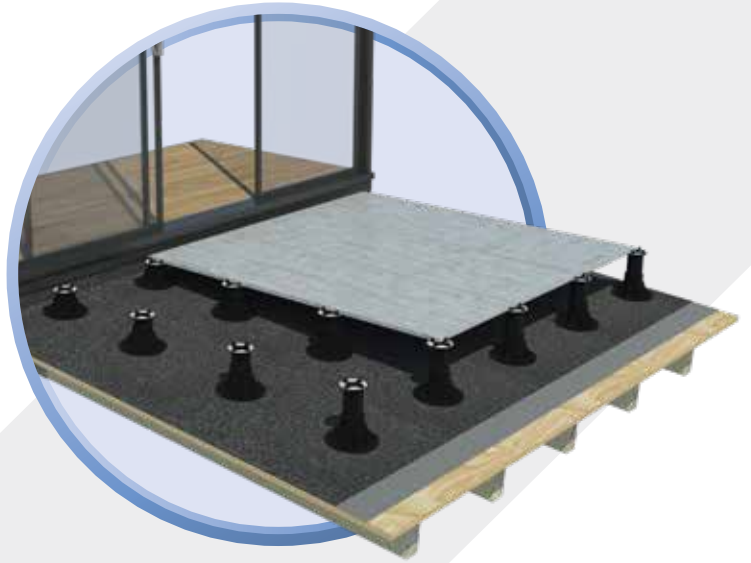

## TIMBER

The quickest way to install a timber deck is to use the NURAJACK™ to support the deck structure. NURAJACKS™ can withstand up to 1000kg per jack and can be installed over any stable non-eroding surface. Perfect for creating level entries and indoor/outdoor flow with ease.





## UNIQUE FEATURES & BENEFITS

- Easily creates a level deck surface with the patented Self-levelling head
- Strong & stable - Load tested to withstand loads up to 1000kg
- Easy Height-Adjustment Feature with NURAJACK™ Adjustment Key
- Easy to replace tiles & timber decking
- Durable - 20 year warranty
- Easy access to water proofing membrane below
- Sizes from 8mm to 550mm
- Void accommodates services which can be placed under deck surface
- Increases the acoustic performance - foot fall noise is minimised from travelling to the inside of the building
- Windproof options available
- Level indoor-outdoor flow
- Meets Building Code requirements
- Made in Italy - designed & manufactured to the highest standards & quality.

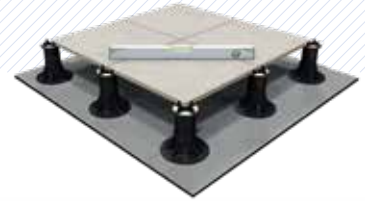



## Nurajack™ Windproof

For over a decade now the NURAJACK™ system has been used successfully, often in challenging situations, throughout New Zealand. There are certain unique projects though where the client desires that tiles be constrained. For this purpose, the NURAJACK™ Windproof (V2) has been developed.



The system consists of a metal clip that is attached to the head of the NURAJACK™ and has the function of anchoring the tile to the head, without using glues or screws. This holds each paver to the NURAJACK™ and distributes the weight of the entire deck across all the tiles – prohibiting uplift of the individual pavers.

The system can withstand wind speeds up to 212km/h (59m/s) or 2166N/m<sup>2</sup> of upward pressure. If increased wind loading is expected, consider increasing the weight of the paver or using an aluminium framed system (such as [www.outdure.com](http://www.outdure.com)) and tying the frame into the structure of the building utilising the Nuralite Fixing Plate fixing system.

### CONSIDERATIONS:

- The tiles/pavers used for this type of system must be milled in the 4 corners to accommodate the clips. This can be done off-site or onsite utilising a grinder and a table.
- The NURAJACK™ Skirting Trim should be used to protect the perimeter of the tiled installation.





**Invisible:** The Windproof clips are hidden.

**Removable:** It allows for the inspection of the underlying surface with the simple removal of the windproof clips.

**Adjustable:** All features of the NURAJACK™ are still available – Self levelling, height adjustment with NURAJACK™ Adjustment Key etc.

**Fixing:** It does not require adhesives or screws.

**Resistance:** Tested to a wind load of 2166N/m<sup>2</sup> – calculated windspeed of 212km/h (59m/s). Absorbs expansion and structural movements.

**Installation:** Visit [www.nurajack.co.nz/windproof](http://www.nurajack.co.nz/windproof) for more information including installation video.

**Compatibility:** It is compatible with any type of structural tile or paver.

FIXING CLIPS  
ATTACH TO TABS

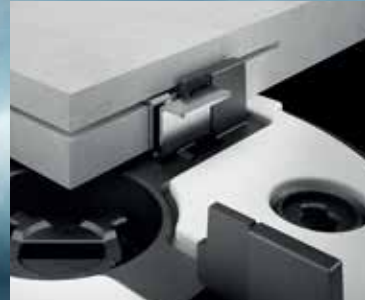

# WINDPROOF



**STAR.T**  
8-15mm



**STAR.B**  
5mm



**SHIM 1,2,3.**



**NURAJACK™  
HEAD LOCKER**

### NURAJACK™ Star.T (NJST)

The smallest NURAJACK™ is the NURAJACK™ Star.T. Starting at a height of 8mm, The NURAJACK™ Star.T can be adjusted up to 15mm. The NURAJACK™ Star.T is levelled using a NURAJACK™ Star.T Slope Corrector. It may be that the installer is satisfied with the tiles following the fall of the membrane, in which case no levelling of the NURAJACK™ Star.T is required.

### NURAJACK™ Star.B (NJSB)

The NURAJACK™ Star.B is a 5mm base for the NURAJACK™ Star.T. The NURAJACK™ Star.B bases can be stacked under the NURAJACK™ Star.T up to 3 high, giving the NURAJACK™ Star.T and Star.B combination an adjustable size of between 8mm to 30mm.

### NURAJACK™ Shim (NJS)

The NURAJACK™ Shim is designed for use with the NURAPAD™ and NURAJACK™. The Shim can be used to accommodate any variance in thickness of pavers or tiles. They can also be used to level a NURAPAD™ or NURAJACK™ Star.T if necessary.

### NURAJACK™ Head Locker (NJHL)

When installing smaller cut tiles adjacent to full tiles, it may be necessary to lock the self-levelling head to stop excessive movement. The NURAJACK™ Head Locker is designed to clip into place and lock the NURAJACK™'s self-levelling head



**ADJUSTMENT  
KEY**



**ACOUSTIC  
SEPARATION PAD  
3mm**



**TILE CLADDING  
SPACER**

### Tilehead Adjustment Key (NJAK)

NURAJACKS™ can be adjusted by the NURAJACK™ Adjustment Key even without the tiles being uplifted. The NURAJACK™ Adjustment Key simply slips between the tiles and into a slot in the top of the NURAJACK™ or NURAJACK™ Star.T and when turned the NURAJACK™ will adjust up and down. The NURAJACK™ Adjustment Key speeds up installation and is ideal for minor adjustments. If installing heavy stone or concrete pavers, one or two pavers may need to be lifted before adjusting the NURAJACK™.

### NURAJACK™ Acoustic Separation Pad (NJSIL)

Footfall noise on any deck area can be minimised through using the NURAJACK™ Acoustic Separation Pad. The NURAJACK™ Acoustic Separation Pad is a self-adhesive disc that adheres to the base of the NURAJACK™. It will provide a NURAJACK™ SE3 with a total of 25dB (IIC:25) reduction in acoustic transference noise. Acoustic Separation Pads can also be used as a slip layer between a NURAJACK™ and an incompatible membrane.

### Tile Cladding Spacer (NJTCS)

Under the building code a space must be maintained between the installed tiles and the wall, cladding, joinery or balustrade. Nuralite's Tile Cladding Spacers are a self-adhesive rubber bumper available in 5mm, 10mm and 14mm sizes and maintain the space required. Each Tile Cladding Spacer is slightly compressible and needs to be compressed in place during installation.



NJMS

### NURAJACK™ Mini Spacer (NJMS)

The NURAJACK™ Mini Spacer is designed for installing 20mm tiles / structural pavers over compacted base-course and sand. Available in bags of 10.



NJMS\*

### NURAJACK™ Mini Spacer + Spike (NJMS\*)

The NURAJACK™ Mini Spacer + Spike is designed for installing 20mm tiles / structural pavers over grass. Available in bags of 10.

NURAJACK™  
VERTICAL CLIP

### NURAJACK™ Vertical Clip (NJVC)

The NURAJACK™ Vertical Clip will hold 20mm tiles in place vertically under a leading edge of a NURAJACK™. This is sometimes required when the edge of a deck is exposed or the underside of the deck can be seen through a glass balustrade.

NURAJACK™  
TILE & TIMBER  
CLADDING CLIP

### NURAJACK™ Tile & Timber Cladding Clip (NJTCC)

Similar to the Tile Cladding Spacers and suitable for both tile and timber decks the NJTCC will maintain a gap between the deck structure and the verticle surface as required by the building code. To be affixed at the end of each joist around the perimeter of the deck.

ACOUSTIC  
SEPARATION PAD  
3mm

### NURAJACK™ Acoustic Separation Pad (NJSIL)

SEE SAME DETAIL AS TILE ACCESSORY OPPOSITE.

NURAJACK™  
TILE & TIMBER  
CLADDING CLIP

### NURAJACK™ Tile & Timber Cladding Clip (NJTCC)

SEE SAME DETAIL AS TILE ACCESSORY OPPOSITE.



NURAPAD™

### NURAPAD™ 12mm Low Profile Deck Pedestal

Where there is not enough room for a joist and a NURAJACK™, a NURAPAD™ can be used. NURAPAD™ are designed to sit under a timber or aluminium joist. NURAPAD™ can accommodate timber joists up to 50mm thick and do not need to be affixed to the joist - the joist will key into the top of the NURAPAD™. NURAPAD™ can be used as a cradle to support a tapered joist or until there is enough space for a NURAJACK™ SE.

### KEY BENEFITS OF NURAPAD™:

- 12mm tall polypropylene plastic disk with upright plastic tabs for the spacing of timber joists (or tiles).
- Large pad to evenly distribute the weight of the deck.
- NURAPAD™ can be stacked on top of each other or rubber shims (NJS) are available to adjust for height.
- Each NURAPAD™ can be separated into quarters to facilitate installation near corners & obstructions.
- MADE IN ITALY to the highest standards.

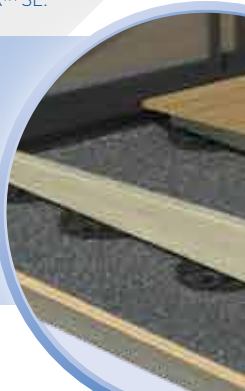

## SPEC DRAWING FOR TILE DECKS

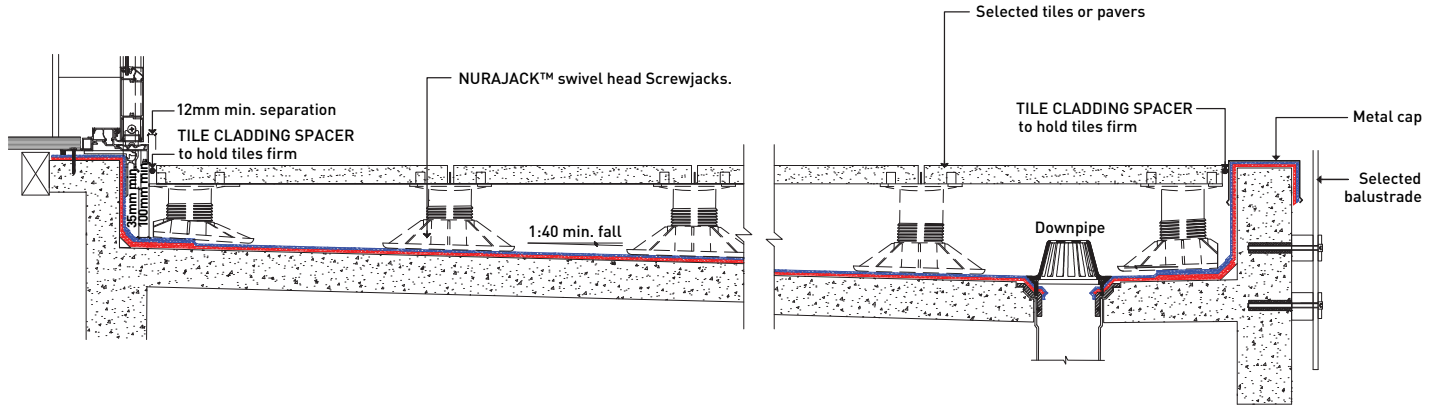

## TECHNICAL INFORMATION &amp; INSTALLATION REQUIREMENTS

**Warranty**

NURAJACKS™ are covered by a full 20-Year Warranty.

**Specify Nuraply 3PM Waterproofing Membrane with NURAJACKS™**

For a high-performance, fully warranted system, specify Nuraply 3PM waterproofing membrane with NURAJACKS™ to support tiles, pavers or decking. Nuralite offers a 20-Year material performance warranty on all products installed as part of the complete system. See [www.nuralite.co.nz](http://www.nuralite.co.nz) for more information.

**System Compatibility is Important**

If you are intending to install NURAJACKS™ over an alternative waterproofing system please check with

the supplier beforehand to ensure all products on the deck are compatible.

**Structural Tiles are a Must**

A structural tile or paver must be used with the NURAJACK™ system. Before purchasing your tile or paver check that it is strong enough to carry foot traffic weight when supported by NURAJACKS™. You will need to get the supplier to warrant it will work with the NURAJACK™ system. It is the tile/paving suppliers responsibility to specify the quantity of NURAJACKS™ required to support each tile/paver.

**Prior to Installation**

The waterproofing membrane must be clean

and clear of foreign objects before installing NURAJACKS™.

**Strength**

NURAJACKS™ are made from high-density polypropylene injection moulding. Their strength is demonstrated by their ability to take a maximum loading of 1000kg per NURAJACK™. If heavy loads are anticipated this must be considered when specifying and designing the waterproofing system. Be aware that the NURAJACK™ system is not designed to support moving vehicles such as cars or scissor lifts.

Download your detailed instructions on the use of NURAJACKS™ and the installation at [www.nurajack.co.nz](http://www.nurajack.co.nz)

## SPEC DRAWING FOR TIMBER DECKS

Use a combination of NURAPADS™ and NURAJACKS™.

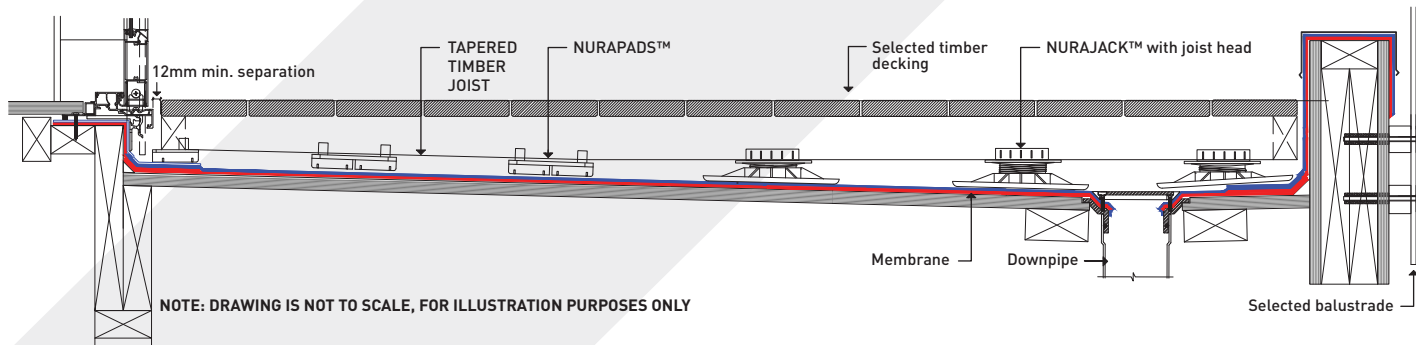

### NURAJACK™ PLACEMENT GRAPH FOR TIMBER DECKS

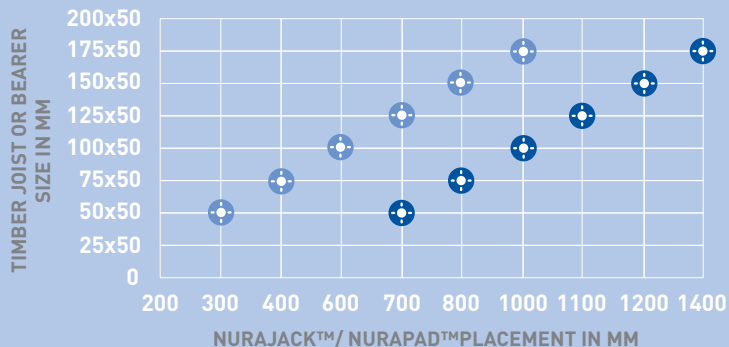

Over membrane decks

Over other surfaces (incl. NURASPIKE™)



# NURASPIKE™



**DURABLE** - Made from powder-coated galvanized steel  
**EASY** - No digging of large holes or concrete required  
**FAST** - Start building a deck immediately after the NURASPIKE™ is installed flush in ground

## Deck footings - made easy

The new innovative NURASPIKE™ is the fastest & easiest way to create deck footings.

- **SIMPLE** - Install with an adjustable NURAJACK™ directly under a joist or bearer to create a low-profile deck over grass or dirt.
- **DURABLE** - Made from powder-coated galvanized steel to stand the test of time.
- **ELIMINATES EXTRA BACK BREAKING WORK** - No boring or digging of large holes required, simply hammer flush into the ground.
- **SAVES TIME & EFFORT** - No concrete needed, instead the unique NURASPIKE™ design supports NURAJACK™ firmly on the ground.
- **DECKING MADE EASY** - Use with any combination of NURAJACKS™
- **STRONG** - Can withstand being installed with a sledge hammer - when used with a NURASPIKE™ Hitting Plate (available separately).



Use with any combination of NURAJACKS™  
More information  
[www.nurajack.co.nz/nuraspike](http://www.nurajack.co.nz/nuraspike)

## NURASPIKE™ HITTING PLATE:

- Protects NURASPIKE™ Top Plate (some indentation is to be expected)
- Reusable for many NURASPIKES™
- Attaches easily to NURASPIKE™
- Made from recycled materials

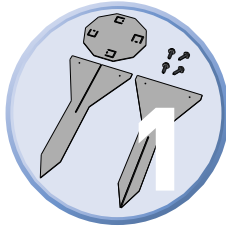

**1. Components of NURASPIKE™ + 4 x self-drilling screws.**

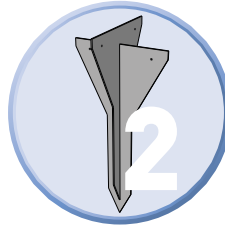

**2. Slide the upper & lower spikes together.**

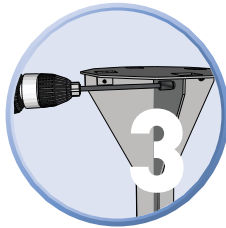

**3. Assemble the NURASPIKE™ by screwing the self-drilling screws in place.**

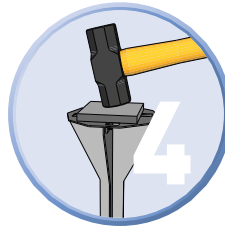

**4. Place the hitting plate on top of the NURASPIKE™ & hammer flush into ground.**

### PRECAUTIONS:

- Check for in ground services where NURASPIKE™ is being installed.
- Nuraspikes must be installed flush in ground.
- Not suitable for waterlogged, heavily compacted or rocky soil - if in doubt test the area first or check with a qualified engineer.
- Use NURASPIKE™ Hitting Plate (available separately).
- Ensure deck complies with any relevant local or governmental building requirements.
- Assemble NURASPIKE™ completely before installation.
- Follow manufacturer's specification for structure & placement of decking boards.
- NURAJACK™ Placement Graph can be found on the previous page of this brochure.

# NURAJACKS™ MAKE IT EASY FOR ALL DECKING REQUIREMENTS

INSTALLATION VIDEOS: See our website for training videos



## SIZES AVAILABLE:

Sizes are available for both tile and timber decks from 8mm to 550mm.



More information including installation videos  
& quantity calculators are available at  
[www.nurajack.co.nz](http://www.nurajack.co.nz)



PROUDLY DISTRIBUTED BY: NURALITE - FLAT ROOFS | BUILT RIGHT  
60D Leon Leicester Ave. Mt Wellington, Auckland, NEW ZEALAND  
P 09 579 2046 F 09 579 5136 E info@nurajack.co.nz  
[www.nuralite.co.nz](http://www.nuralite.co.nz)

